

As a global company, we offer our products and support worldwide.

The LR Series conforms to international standards. The PATLITE group has built a global sales network to effectively provide goods and services to customers anywhere.

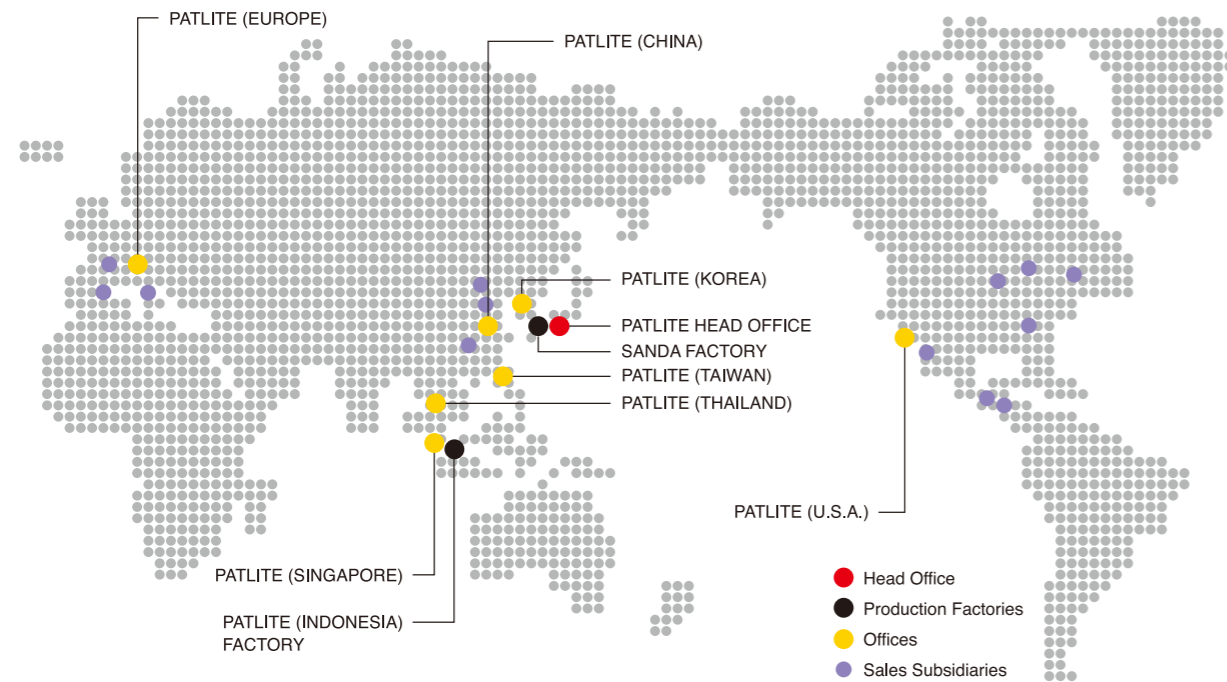

PATLITE Corporation

4-1-3, Kyutaromachi, Chuo-ku, Osaka 541-0056 Japan
TEL. +81-6-7711-8953 FAX. +81-6-7711-8961 E-mail: overseas@patlite.co.jp

PATLITE (U.S.A.) Corporation

20130 S. Western Ave. Torrance, CA 90501, U.S.A.
TEL. +1-310-328-3222 FAX. +1-310-328-2676 E-mail: sales@patlite.com

PATLITE (SINGAPORE) PTE LTD

No.2 Leng Kee Road, #05-01 Thye Hong Centre, Singapore 159086
TEL. +65-6226-1111 FAX. +65-6324-1411 E-mail: sales@patlite.com.sg

PATLITE (CHINA) Corporation

Room 1102-1103, No.55, Lane 777, Guangzhong Road (West), Zhabei District, Shanghai, China 200072
TEL. +86-21-6630-8969 FAX. +86-21-6630-8938 E-mail: sales@patlite.cn

PATLITE Europe GmbH

Am Soeldnermoos 8, D-85399 Hallbergmoos, Germany
TEL. +49-811-9981-9770-0 FAX. +49-811-9981-9770-90 E-mail: info@patlite.eu

PATLITE KOREA CO., LTD.

A2603, Daesung, D-POLIS, 606, Seobusaet-gil, Geumcheon-gu, Seoul, 08504, Korea
TEL. +82-2-523-6636 FAX. +82-2-861-9919 E-mail: sales@patlite.co.kr

PATLITE TAIWAN CO., LTD.

7F. No. 91, Huayin St, Datong District Taipei, Taiwan R.O.C
TEL. +886-2-2555-1611 FAX. +886-2-2555-1621 E-mail: info@patlite.tw

PATLITE (THAILAND) CO., LTD.

Olympia Thai Tower, 15th Floor 444 Ratchadapisek Road Samsenok, Huay Kwang Bangkok 10310, Thailand
TEL. +66-2-541-5431 FAX. +66-2-541-5429 E-mail: sales@patlite.co.th

<http://www.patlite.com>

●PATLITE, the PATLITE logo are either registered trademarks or trademarks of PATLITE Corporation in JAPAN and/or other countries.

CAUTION
To ensure correct use of these products, read the "Instruction Manual" prior to use. Failure to follow all safeguards can result in fire, electric shock, or other accidents. Specifications are subject to change without notice.



PATLITE ECO PROJECT
For the benefit of mankind and the earth, Patlite is committed to developing environmentally friendly products.

0-AG10B EN 1808 A

PATLITE®
New Frontiers in Safety, Security and Comfort.

Signal Tower
LR Series

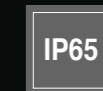

NEMA Type 4X, 13 360° Buzzer Modular

www.patlite.com

Signal Tower LR Series Modular LED Signal Tower

- φ40mm LR4
- φ50mm LR5
- φ60mm LR6
- φ70mm LR7



Modular Components Example



Optional Parts Example



A Uniform 360° Light-Emitting Design

The new LED color module features a new, unique interior lens construction that achieves a fuller, more uniform 360° degree light output. Light color is vibrant with more emission area for reliable indication from further distances.

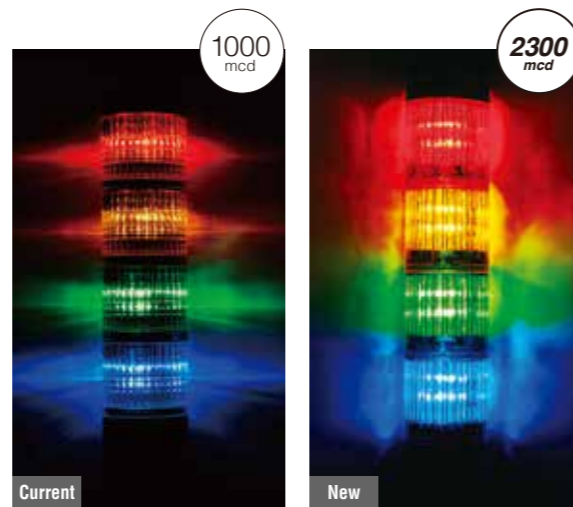

LCE-A Series (φ40) LR4 Series (φ40)

More than Twice the Light Output*

The LR Series lens distributes light more efficiently, increasing luminous intensity by more than double that of our current models.

* Based on the φ40 Red LED Model

Unique Method of Fully Enclosed Sound Module

Inspired by a drum percussion instrument, the fully enclosed sound module is able to more efficiently vibrate sound waves, producing even 360° omnidirectional sound resonance. Resistance to water and dust is also increased.

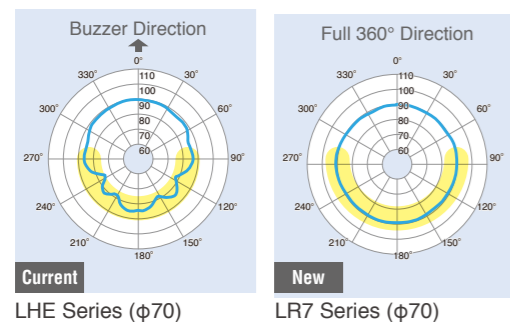

LHE Series (φ70) LR7 Series (φ70)

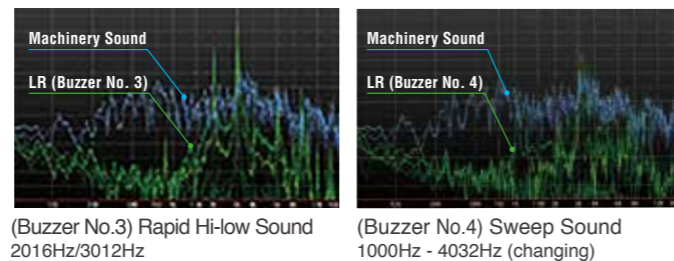

(Buzzer No.3) Rapid Hi-low Sound 2016Hz/3012Hz (Buzzer No.4) Sweep Sound 1000Hz - 4032Hz (changing)

New Sounds Heard Above the Noise

4 built-in buzzer sounds. Buzzer sounds No. 3 and No. 4 are designed at a higher variable frequency to be heard above the noise of surrounding machinery. Alternatively, a sound reduction function of approx. -10dB is included for use in quieter environments.

* Four Buzzer Sounds

- No.1 Rapid Intermittent sound
- No.2 Continuous sound
- No.3 Rapid Hi-low
- No.4 Sweep sound

Modular System Design

Traditional stack lights typically require additional threaded shafts or tools to reconfigure LED units. The LR modular system design redefines signal tower assembly by making customization and repair seamless.

LED/Buzzer Unit Removal



- 1) Hold the LED/Buzzer Unit or Base and turn counter-clockwise to unlock the unit.
- 2) Pull straight up to remove the unit.

LED Unit Attachment

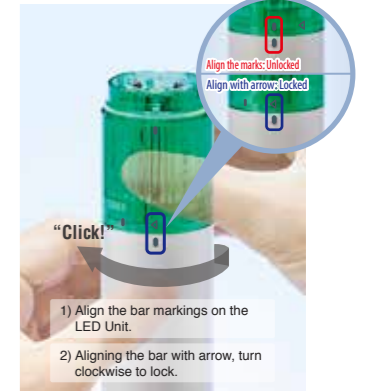

- 1) Align the bar markings on the LED Unit.
- 2) Aligning the bar with arrow, turn clockwise to lock.

Reorganizing Modules is Effortless

The LR modular system makes reconfiguring the color order simple with its twist-and-lock design. Replacing and reconfiguring LED units or adding a buzzer module is easier than ever.



Scan to see this in action



Smooth Surface

The LR base, LED units and buzzer modules secure together tight and flush, creating a smooth surface, ideal for easy cleaning and water run off.

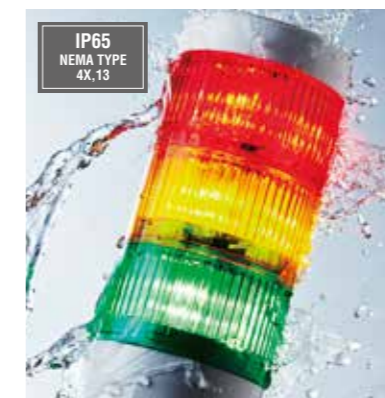

Environmental Performance

Features a rugged structure with the following ratings: IP65 / NEMA Type 4x, 13 withstands various environmental conditions, such as water and dust.



Upgraded Materials

Upgrading from an ABS to Polycarbonate material, and silicon resin O-rings, results in a more lightweight, shock and water resistant product.





New Lineup

Clear-globe LED Unit

LR4-E-RZ

- 4 (Φ40) R (Red)
- 5 (Φ50) Y (Amber)
- 6 (Φ60) G (Green)
- B (Blue)



LR4 LR5 LR6

Clear globes for R,Y,G,B

Individual Unit
Pre-assembled*
*LR4, LR6 Only

Multi-color LED Unit

LR6-E-MZ

7 colors

LR6

Individual Unit

It displays 7 colors in one unit.
(Red/Green/Blue/Amber/
Cyan/Purple/White)

By connecting (red, green, blue) wires, the colors light up.

Wire Color	Red	Red/Green	Blue	Green	Blue/Green	Red/Blue	Red/Green/Blue
LED Color	Red	Amber	Blue	Green	Cyan	Purple	White

Wireless Data Acquisition System

Transmitters



Signal Tower LR6 Transmitter
WDT-6LR-Z2

Corresponding Model LR6 Series	Current Consumption max 55mA
Transmission Distance 20m*2	



Signal Tower LR5 Transmitter
WDT-5LR-Z2

Corresponding Model LR5 Series	Current Consumption max 55mA
Transmission Distance 20m*2	

Receiver



Receiver
WDR-LE-Z2

Number of Transmitter 20 Units*1 MAX 30 Units	Connection Type LAN/USB
Transmission Distance typ. 65m*3	Multiple Units*3

- *1 Radio signal quality will depend on the environment, device location and number of connections.
- *2 Due to the characteristic of radio waves, the connection distances are reference values.
- *3 Two or more receiver units can operate simultaneously with LAN connections.
(Ask your PATLITE Sales Representative for details.)

Monitor and acquire critical equipment data

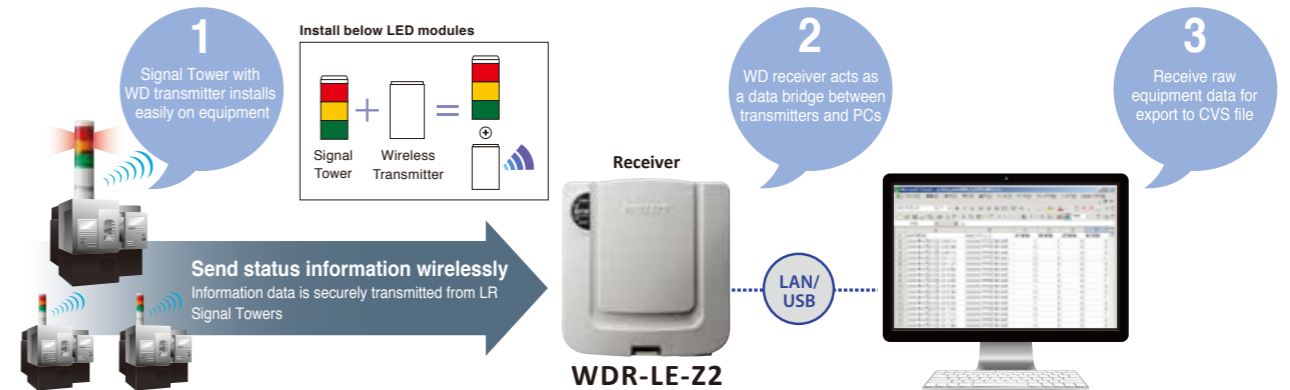

Manual Control Signal Tower

HSST-3M2-RYG



Clear-globe Type

Mounting Image

Assembly Process



What is HSST?

It is a kit featuring an LR5 Signal Tower, a switch box, AC/DC adaptor, and mounting hardware. This system can be used for a wide range of applications such as, improving efficiency of production assembly lines and discreet communications in call centers.

Assembly Line Lighting Display

- Problem Occurred
- Low Material Stock
- Need Assistance

Customer Support / Call Center



Call Status Display
Need a Manager
On Hold
On Call

Rated Voltage	Size	Operating Specifications	Tiers	Model	Color
100V - 240V AC	φ50	Switch ON/OFF Lighting Control	3	HSST-3M2-RYG	Clear Red/Amber/Green

LR5/LR7 Screwless Terminal Knock-out Mount

Dual mount base unit allows for direct or pole mounting



Screw and nut accessories included.

Accessory			
LR5 - KT	Hexagon Bolt (M3 x 20)	Hexagon Nut with Flange (M3)	3 pcs.
LR7 - KT	Hexagon Bolt (M4 x 20)	Hexagon Nut with Flange (M4)	3 pcs.

Installation Method 1

Direct Mount (Using accessories)
Mount on pole bracket by knocking out holes with the tapping screws included with the bracket.

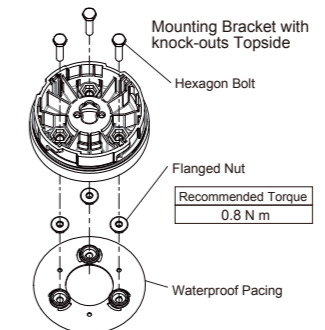

Installation Method 2

Pole Mount (Not Using accessories)
Mount directly by knocking out holes in the bracket and securing with nuts and bolts.

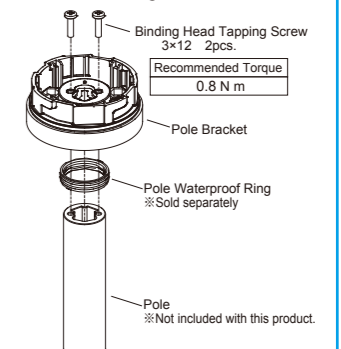

*Please refer to the Complete Operation Manual for details of installation.

Signal Tower

LR Series Pre-assembled Models

φ40mm Model Code (Ex.) **LR4-502WJBW-RYGBCZ**

Model ① ② ③ ④ ⑤ ⑥ ⑦

- ① Tiers: 1 = 1 Tier, 2 = 2 Tiers, 3 = 3 Tiers, 4 = 4 Tiers, 5 = 5 Tiers
 - ② Rated Voltage: 02 = 24V DC
 - ③ Mounting/Wiring: WJ = Direct Mount/Cable, LJ = Pole Mount with L-bracket/Cable, PJ = Pole Mount with Circular Bracket/Cable, QJ = Pole Mount with Folding Bracket/Cable*2
 - ④ Flashing/Buzzer: B = With Flashing/Buzzer, N = No Flashing/Buzzer
 - ⑤ Body Color: W = Off-white, U = Silver*3
 - ⑥ LED Module Color: R = Red, Y = Amber, G = Green, B = Blue, C = White
 - ⑦ Globe Type: Blank = Color Globe, Z = Clear Globe
- *1 For WJ, LJ and PJ type only *2 For 24V DC and Off-white type only *3 For 24V DC type WJ, LJ and PJ type only

φ50mm Model Code (Ex.) **LR5-502WJBW-RYGBCZ**

Model ① ② ③ ④ ⑤ ⑥ ⑦

- ① Tiers: 1 = 1 Tier, 2 = 2 Tiers, 3 = 3 Tiers, 4 = 4 Tiers, 5 = 5 Tiers
- ② Rated Voltage: 01 = 12V DC, 02 = 24V DC
- ③ Mounting/Wiring: WJ = Direct Mount/Cable, LJ = Pole Mount with L-bracket/Cable, PJ = Pole Mount with Circular Bracket/Cable
- ④ Flashing/Buzzer: B = With Flashing/Buzzer, N = No Flashing/Buzzer
- ⑤ Body Color: W = Off-white, U = Silver*3
- ⑥ LED Module Color: R = Red, Y = Amber, G = Green, B = Blue, C = White
- ⑦ Globe Type: Blank = Color Globe, Z = Clear Globe

φ60mm Model Code (Ex.) **LR6-502WJBW-RYGBCZ**

Model ① ② ③ ④ ⑤ ⑥ ⑦

- ① Tiers: 1 = 1 Tier, 2 = 2 Tiers, 3 = 3 Tiers, 4 = 4 Tiers, 5 = 5 Tiers
 - ② Rated Voltage: 02 = 24V DC
 - ③ Mounting/Wiring: WJ = Direct Mount/Cable, LJ = Pole Mount with L-bracket/Cable, PJ = Pole Mount with Circular Bracket/Cable, QJ = Pole Mount with Folding Bracket/Cable*2, WC = Direct Mount/M12 Connector*2
 - ④ Flashing/Buzzer: B = With Flashing/Buzzer, N = No Flashing/Buzzer
 - ⑤ Body Color: W = Off-white, U = Silver*3
 - ⑥ LED Module Color: R = Red, Y = Amber, G = Green, B = Blue, C = White, M = Multi Color
 - ⑦ Globe Type: Blank = Color Globe, Z = Clear Globe
- *1 For WJ, LJ and PJ type only *2 For 24V DC and Off-white type only *3 For 24V DC type WJ, LJ and PJ type only

φ70mm Model Code (Ex.) **LR7-502WJBW-RYGBC**

Model ① ② ③ ④ ⑤ ⑥





- ① Tiers: 1 = 1 Tier, 2 = 2 Tiers, 3 = 3 Tiers, 4 = 4 Tiers, 5 = 5 Tiers
- ② Rated Voltage: 02 = 24V DC
- ③ Mounting/Wiring: WJ = Direct Mount/Cable
- ④ Flashing/Buzzer: B = With Flashing/Buzzer, N = No Flashing/Buzzer
- ⑤ Body Color: W = Off-white
- ⑥ LED Module Color: R = Red, Y = Amber, G = Green, B = Blue, C = White





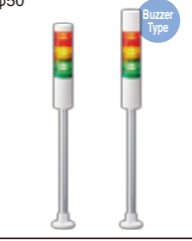
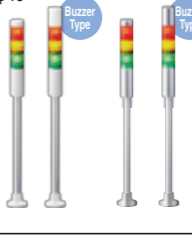

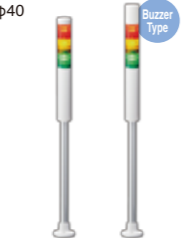
Mounting Type	Rated Voltage	Size	Flash/Buzzer	Tiers	Model	Power Consumption	Mass
Pole Mount with Folding Bracket	24V DC	φ40	-	1	LR4-102QJNW	1.0W	0.455kg
				2	LR4-202QJNW	2.0W	0.490kg
				3	LR4-302QJNW	3.0W	0.525kg
				4	LR4-402QJNW	4.0W	0.560kg
				5	LR4-502QJNW	5.0W	0.595kg
			O	1	LR4-102QJBW	2.0W	0.490kg
				2	LR4-202QJBW	3.0W	0.525kg
				3	LR4-302QJBW	4.0W	0.560kg
				4	LR4-402QJBW	5.0W	0.595kg
				5	LR4-502QJBW	6.0W	0.630kg
		φ60	-	1	LR6-102QJNW	1.0W	0.520kg
				2	LR6-202QJNW	2.0W	0.580kg
				3	LR6-302QJNW	3.0W	0.640kg
				4	LR6-402QJNW	4.0W	0.700kg
				5	LR6-502QJNW	5.0W	0.760kg
			O	1	LR6-102QJBW	2.0W	0.580kg
				2	LR6-202QJBW	3.0W	0.640kg
				3	LR6-302QJBW	4.0W	0.700kg
				4	LR6-402QJBW	5.0W	0.760kg
				5	LR6-502QJBW	6.0W	0.820kg

Mounting Type	Rated Voltage	Size	Flash/Buzzer	Tiers	Model	Power Consumption	Mass
Direct Mount	12V DC	φ50	-	1	LR5-101WJNW	1.0W	0.240kg
				2	LR5-201WJNW	2.0W	0.280kg
				3	LR5-301WJNW	3.0W	0.320kg
				4	LR5-401WJNW	4.0W	0.360kg
				5	LR5-501WJNW	5.0W	0.400kg
			O	1	LR5-101WJBW	2.1W	0.290kg
				2	LR5-201WJBW	3.1W	0.330kg
				3	LR5-301WJBW	4.1W	0.370kg
				4	LR5-401WJBW	5.1W	0.410kg
				5	LR5-501WJBW	6.1W	0.450kg
	24V DC	φ40	-	1	LR4-102WJNW[U]	1.0W	0.205kg/0.355kg
				2	LR4-202WJNW[U]	2.0W	0.240kg/0.390kg
				3	LR4-302WJNW[U]	3.0W	0.275kg
				3	LR4-302WJNW-[Z] CLEAR	3.0W	0.275kg/0.425kg
				4	LR4-402WJNW[U]	4.0W	0.310kg/0.460kg
			O	1	LR4-102WJBW[U]	2.0W	0.240kg/0.390kg
				2	LR4-202WJBW[U]	3.0W	0.275kg/0.425kg
				3	LR4-302WJBW[U]	4.0W	0.310kg/0.460kg
				3	LR4-302WJBW-[Z] CLEAR	4.0W	0.310kg
				4	LR4-402WJBW[U]	5.0W	0.345kg/0.495kg
		φ50	-	1	LR5-102WJNW	1.0W	0.240kg
				2	LR5-202WJNW	2.0W	0.280kg
				3	LR5-302WJNW	3.0W	0.360kg
				4	LR5-402WJNW	4.0W	0.360kg
				5	LR5-502WJNW	5.0W	0.400kg
O			1	LR5-102WJBW	2.0W	0.290kg	
			2	LR5-202WJBW	3.0W	0.330kg	
			3	LR5-302WJBW	4.0W	0.370kg	
			4	LR5-402WJBW	5.0W	0.410kg	
			5	LR5-502WJBW	6.0W	0.450kg	
φ60	-	1	LR6-102WJNW[U]	1.0W	0.280kg/0.410kg		
		2	LR6-202WJNW[U]	2.0W	0.340kg/0.470kg		
		3	LR6-302WJNW[U]	3.0W	0.400kg/0.530kg		
		3	LR6-302WJNW-[Z] CLEAR	3.0W	0.400kg		
		4	LR6-402WJNW[U]	4.0W	0.460kg/0.590kg		
	O	1	LR6-102WJBW[U]	2.0W	0.340kg/0.470kg		
		2	LR6-202WJBW[U]	3.0W	0.400kg/0.530kg		
		3	LR6-302WJBW[U]	4.0W	0.460kg/0.590kg		
		3	LR6-302WJBW-[Z] CLEAR	4.0W	0.460kg		
		4	LR6-402WJBW[U]	5.0W	0.520kg/0.650kg		
φ70	-	1	LR7-102WJNW	1.0W	0.305kg		
		2	LR7-202WJNW	2.0W	0.370kg		
		3	LR7-302WJNW	3.0W	0.435kg		
		4	LR7-402WJNW	4.0W	0.500kg		
		5	LR7-502WJNW	5.0W	0.565kg		
	O	1	LR7-102WJBW	2.0W	0.375kg		
		2	LR7-202WJBW	3.0W	0.440kg		
		3	LR7-302WJBW	4.0W	0.505kg		
		4	LR7-402WJBW	5.0W	0.570kg		
		5	LR7-502WJBW	6.0W	0.635kg		
100 - 240V AC	φ40	-	1	LR4-1M2WJNW	1.5W	0.285kg	
			2	LR4-2M2WJNW	3.0W	0.320kg	
			3	LR4-3M2WJNW	4.5W	0.355kg	
			4	LR4-4M2WJNW	6.0W	0.390kg	
			5	LR4-5M2WJNW	7.5W	0.425kg	
		O	1	LR4-1M2WJBW	3.0W	0.320kg	
			2	LR4-2M2WJBW	4.5W	0.355kg	
			3	LR4-3M2WJBW	6.0W	0.390kg	
			4	LR4-4M2WJBW	7.5W	0.425kg	
			5	LR4-5M2WJBW	9.0W	0.460kg	
	φ60	-	1	LR6-1M2WJNW	1.5W	0.380kg	
			2	LR6-2M2WJNW	3.0W	0.440kg	
			3	LR6-3M2WJNW	4.5W	0.500kg	
			4	LR6-4M2WJNW	6.0W	0.560kg	
			5	LR6-5M2WJNW	7.5W	0.620kg	
		O	1	LR6-1M2WJBW	3.0W	0.440kg	
			2	LR6-2M2WJBW	4.5W	0.500kg	
			3	LR6-3M2WJBW	6.0W	0.560kg	
			4	LR6-4M2WJBW	7.5W	0.620kg	
			5	LR6-5M2WJBW	9.0W	0.680kg	

Signal Tower

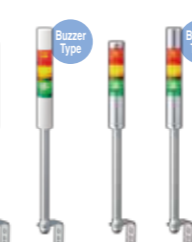
LR Series Pre-assembled Models

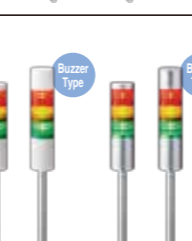
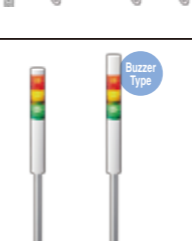
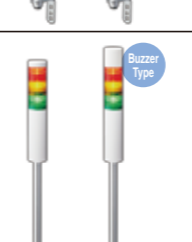
Mounting Type	Rated Voltage	Size	Flash/Buzzer	Tiers	Model	Power Consumption	Mass
	12V DC		-	1	LR5-101PJNW	1.0W	0.420kg
				2	LR5-201PJNW	2.0W	0.460kg
				3	LR5-301PJNW	3.0W	0.500kg
				4	LR5-401PJNW	4.0W	0.540kg
				5	LR5-501PJNW	5.0W	0.580kg
			O	1	LR5-101PJBW	2.1W	0.470kg
				2	LR5-201PJBW	3.1W	0.510kg
				3	LR5-301PJBW	4.4W	0.550kg
				4	LR5-401PJBW	5.1W	0.590kg
				5	LR5-501PJBW	6.1W	0.630kg
	24V DC		-	1	LR4-102PJNW[U]	1.0W	0.395kg/0.545kg
				2	LR4-202PJNW[U]	2.0W	0.430kg/0.580kg
				3	LR4-302PJNW[U]	3.0W	0.465kg/0.615kg
				4	LR4-402PJNW[U]	4.0W	0.500kg/0.650kg
				5	LR4-502PJNW[U]	5.0W	0.535kg/0.685kg
			O	1	LR4-102PJBW[U]	2.0W	0.430kg/0.580kg
				2	LR4-202PJBW[U]	3.0W	0.465kg/0.615kg
				3	LR4-302PJBW[U]	4.0W	0.500kg/0.650kg
				4	LR4-402PJBW[U]	5.0W	0.535kg/0.685kg
				5	LR4-502PJBW[U]	6.0W	0.570kg/0.720kg
24V DC		-	1	LR5-102PJNW	1.0W	0.420kg	
			2	LR5-202PJNW	2.0W	0.460kg	
			3	LR5-302PJNW	3.0W	0.500kg	
			4	LR5-402PJNW	4.0W	0.540kg	
			5	LR5-502PJNW	5.0W	0.580kg	
		O	1	LR5-102PJBW	2.0W	0.470kg	
			2	LR5-202PJBW	3.0W	0.510kg	
			3	LR5-302PJBW	4.0W	0.550kg	
			4	LR5-402PJBW	5.0W	0.590kg	
			5	LR5-502PJBW	6.0W	0.630kg	
24V DC		-	1	LR6-102PJNW[U]	1.0W	0.460kg/0.590kg	
			2	LR6-202PJNW[U]	2.0W	0.520kg/0.650kg	
			3	LR6-302PJNW[U]	3.0W	0.580kg/0.710kg	
			4	LR6-402PJNW[U]	4.0W	0.640kg/0.770kg	
			5	LR6-502PJNW[U]	5.0W	0.700kg/0.830kg	
		O	1	LR6-102PJBW[U]	2.0W	0.520kg/0.650kg	
			2	LR6-202PJBW[U]	3.0W	0.580kg/0.710kg	
			3	LR6-302PJBW[U]	4.0W	0.640kg/0.770kg	
			4	LR6-402PJBW[U]	5.0W	0.700kg/0.830kg	
			5	LR6-502PJBW[U]	6.0W	0.760kg/0.890kg	
100 - 240V AC		-	1	LR4-1M2PJNW	1.5W	0.475kg	
			2	LR4-2M2PJNW	3.0W	0.510kg	
			3	LR4-3M2PJNW	4.5W	0.545kg	
			4	LR4-4M2PJNW	6.0W	0.580kg	
			5	LR4-5M2PJNW	7.5W	0.615kg	
		O	1	LR4-1M2PJBW	3.0W	0.510kg	
			2	LR4-2M2PJBW	4.5W	0.545kg	
			3	LR4-3M2PJBW	6.0W	0.580kg	
			4	LR4-4M2PJBW	7.5W	0.615kg	
			5	LR4-5M2PJBW	9.0W	0.650kg	
		-	1	LR6-1M2PJNW	1.5W	0.560kg	
			2	LR6-2M2PJNW	3.0W	0.620kg	
			3	LR6-3M2PJNW	4.5W	0.680kg	
			4	LR6-4M2PJNW	6.0W	0.740kg	
			5	LR6-5M2PJNW	7.5W	0.800kg	
O	1	LR6-1M2PJBW	3.0W	0.620kg			
	2	LR6-2M2PJBW	4.5W	0.680kg			
	3	LR6-3M2PJBW	6.0W	0.740kg			
	4	LR6-4M2PJBW	7.5W	0.800kg			
	5	LR6-5M2PJBW	9.0W	0.860kg			

Mounting Type	Rated Voltage	Size	Flash/Buzzer	Tiers	Model	Power Consumption	Mass
	12V DC		-	1	LR5-101LJNW	1.0W	0.530kg
				2	LR5-201LJNW	2.0W	0.570kg
				3	LR5-301LJNW	3.0W	0.610kg
				4	LR5-401LJNW	4.0W	0.650kg
				5	LR5-501LJNW	5.0W	0.690kg
			O	1	LR5-101LJBW	2.1W	0.580kg
				2	LR5-201LJBW	3.1W	0.620kg
				3	LR5-301LJBW	4.1W	0.660kg
				4	LR5-401LJBW	5.1W	0.700kg
				5	LR5-501LJBW	6.1W	0.740kg
	24V DC		-	1	LR4-102LJNW[U]	1.0W	0.495kg/0.645kg
				2	LR4-202LJNW[U]	2.0W	0.530kg/0.680kg
				3	LR4-302LJNW[U]	3.0W	0.565kg/0.715kg
				4	LR4-402LJNW[U]	4.0W	0.600kg/0.750kg
				5	LR4-502LJNW[U]	5.0W	0.635kg/0.785kg
			O	1	LR4-102LJBW[U]	2.0W	0.530kg/0.680kg
				2	LR4-202LJBW[U]	3.0W	0.565kg/0.715kg
				3	LR4-302LJBW[U]	4.0W	0.600kg/0.750kg
				4	LR4-402LJBW[U]	5.0W	0.635kg/0.785kg
				5	LR4-502LJBW[U]	6.0W	0.670kg/0.820kg
24V DC		-	1	LR5-102LJNW	1.0W	0.530kg	
			2	LR5-202LJNW	2.0W	0.570kg	
			3	LR5-302LJNW	3.0W	0.610kg	
			4	LR5-402LJNW	4.0W	0.650kg	
			5	LR5-502LJNW	5.0W	0.690kg	
		O	1	LR5-102LJBW	2.0W	0.580kg	
			2	LR5-202LJBW	3.0W	0.620kg	
			3	LR5-302LJBW	4.0W	0.660kg	
			4	LR5-402LJBW	5.0W	0.700kg	
			5	LR5-502LJBW	6.0W	0.740kg	
24V DC		-	1	LR6-102LJNW[U]	1.0W	0.560kg/0.700kg	
			2	LR6-202LJNW[U]	2.0W	0.620kg/0.760kg	
			3	LR6-302LJNW[U]	3.0W	0.680kg/0.820kg	
			4	LR6-402LJNW[U]	4.0W	0.740kg/0.880kg	
			5	LR6-502LJNW[U]	5.0W	0.800kg/0.940kg	
		O	1	LR6-102LJBW[U]	2.0W	0.620kg/0.760kg	
			2	LR6-202LJBW[U]	3.0W	0.680kg/0.820kg	
			3	LR6-302LJBW[U]	4.0W	0.740kg/0.880kg	
			4	LR6-402LJBW[U]	5.0W	0.800kg/0.940kg	
			5	LR6-502LJBW[U]	6.0W	0.860kg/1.000kg	
100-240V AC*		-	1	LR4-1M2LJNW	1.5W	0.575kg	
			2	LR4-2M2LJNW	3.0W	0.610kg	
			3	LR4-3M2LJNW	4.5W	0.645kg	
			4	LR4-4M2LJNW	6.0W	0.680kg	
			5	LR4-5M2LJNW	7.5W	0.715kg	
		O	1	LR4-1M2LJBW	3.0W	0.610kg	
			2	LR4-2M2LJBW	4.5W	0.645kg	
			3	LR4-3M2LJBW	6.0W	0.680kg	
			4	LR4-4M2LJBW	7.5W	0.715kg	
			5	LR4-5M2LJBW	9.0W	0.750kg	
		-	1	LR6-1M2LJNW	1.5W	0.660kg	
			2	LR6-2M2LJNW	3.0W	0.720kg	
			3	LR6-3M2LJNW	4.5W	0.780kg	
			4	LR6-4M2LJNW	6.0W	0.840kg	
			5	LR6-5M2LJNW	7.5W	0.900kg	
O	1	LR6-1M2LJBW	3.0W	0.720kg			
	2	LR6-2M2LJBW	4.5W	0.780kg			
	3	LR6-3M2LJBW	6.0W	0.840kg			
	4	LR6-4M2LJBW	7.5W	0.900kg			
	5	LR6-5M2LJBW	9.0W	0.960kg			
24V DC		-	3	LR6-302WCNW	3.0W	0.350kg	

* Not suitable for KC (KN 61000-6-4, KN 61000-6-2) and Low Voltage Directive (TEC / EN 60947-5-1, EN 62471).

LR Series Modular Models

Select a Buzzer Unit (for Flashing / Buzzer function)

Size	Color	Model
φ40		LR4-B□
φ50		LR5-B□
φ60		LR6-B□
φ70		LR7-B□

□•••W: Off-white U: Silver K: Black

Select an LED Unit

Size	Color	Model
φ40		LR4-E-R/Y/G/B/C
		LR4-E-RZ/YZ/GZ/BZ CLEAR
φ50		LR5-E-R/Y/G/B/C
		LR4-E-RZ/YZ/GZ/BZ CLEAR
φ60		LR6-E-R/Y/G/B/C
		LR6-E-RZ/YZ/GZ/BZ CLEAR
φ70		LR7-E-R/Y/G/B/C
φ60		LR6-E-MZ Multi-color

Select a Body Unit

Mounting Type	Rated Voltage	Size	Model
	12V DC	φ50	LR5-01WJNW
		φ40	LR4-02WJNW[U]
	24V DC	φ50	LR5-02WJNW
		φ60	LR6-02WJNW[U]
		φ70	LR7-02WJNW
100 - 240V AC	φ40	LR4-M2WJNW	
	φ60	LR6-M2WJNW	
	24V DC	φ50	LR5-02WTNW[U][K]
		φ70	LR7-02WTNW[U][K]
	24V DC	φ50	LR5-02KTNW[U][K]
		φ70	LR7-02KTNW[U][K]
	24V DC	φ60	LR6-02WCNW

Body Unit Model Code

(Ex.) **LR6-02WJNW**

Model ① ② ③ ④ ⑤

- ① Size
4 = φ40
5 = φ50
6 = φ60
7 = φ70
 - ② Rated Voltage
01 = 12V DC*1
02 = 24V DC
M2 = 100 - 240V AC *2
 - ③ Mounting/Wiring
WJ = Direct Mount/Cable
WT = Direct Mount/Terminal*3
KT = Knock-outs Mount/Terminal*3
WC = Direct Mount/M12 Connector*4
LJ = Pole Mount with L-bracket/Cable*5
PJ = Pole Mount with Circular Bracket/Cable*5
QJ = Pole Mount with Folding Bracket/Cable*6
 - ④ Flashing/Buzzer
N = No Flashing/Buzzer
 - ⑤ Body Color
W = Off-white
U = Silver
K = Black*7
- *1 For LR5 models only
*2 For WJ, LJ and PJ mounting with LR4 and LR6 models
*3 For LR5, LR7 DC24V models only
*4 For LR6 DC24V models only
*5 For LR4, LR5 and LR6 models
*6 With LR4 and LR6 DC24V Off-white models only
*7 For LR5, LR7 models only

3 Easy Steps

1 Remove the headcover to setup the body unit

2 Attach from bottom to top, one LED unit at a time to the body unit

3 Replace the headcover, or attach the buzzer unit

See the Movie!!

Scan the QR code to see how easy the LR is to configure.

12V DC
24V DC
100-240V AC
Cable
Terminal

Mounting Type	Rated Voltage	Size	Model
	12V DC	φ50	LR5-01PJNW
		φ40	LR4-02PJNW[U]
	24V DC	φ50	LR5-02PJNW
	12V DC	φ50	LR5-01LJNW
		φ40	LR4-02LJNW[U]
	24V DC	φ50	LR5-02LJNW
	12V DC	φ50	LR5-01LJNW
		φ40	LR4-02LJNW[U]
	24V DC	φ50	LR5-02LJNW
24V DC	φ40	LR4-02QJNW	
	φ60	LR6-02QJNW	

Removable Screwless Terminal

A new removable terminal for easier wiring.

The terminal can be pulled out

Signal Tower

LR Series Optional Parts

Direct Mount Brackets

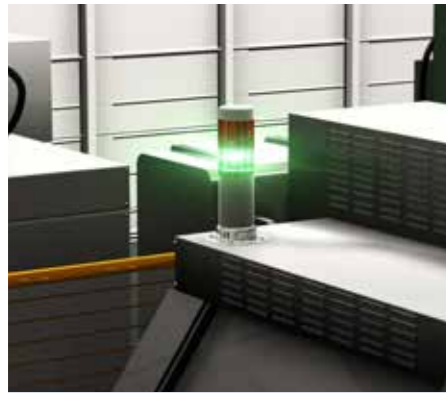

Circular Bracket

Model: SZW-001W

Material: SPCE

■ Mounting Dimensions (Unit: mm)

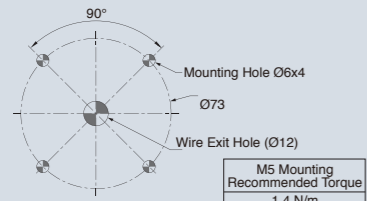

Wall-mount Bracket

Model: SZK-002W/U/K

Material: PC



■ Mounting Dimensions (Unit: mm)

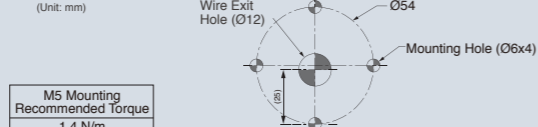

Model: SZK-003W/U/K

Material: PC



Model: SZK-004W

Material: PC

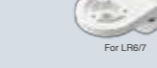

※An M16xP1.5 cable gland attachment needs to be purchased additionally

The wiring can exit through the bracket.

N Type Aluminum Pole Brackets

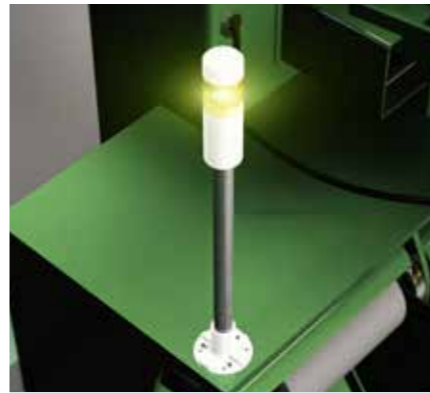

Circular Multiple-mount Bracket

Model: SZP-001W

Accessories: Waterproof Packing Pole Waterproof Ring Binding Head Tapping Screw (2 pcs.)

Material: PC

■ Mounting Dimensions (Unit: mm)

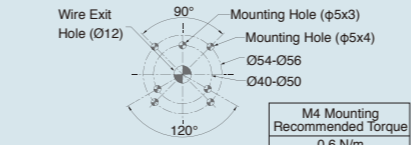

Circular Bracket

Model: SZP-002U

Accessories: Pole Waterproof Ring Binding Head Tapping Screw (2 pcs.)

Material: ADC12

■ Mounting Dimensions (Unit: mm)

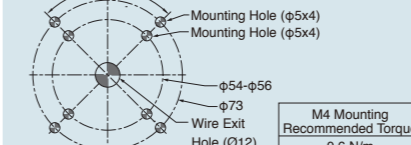

Circular Bracket

Model: SZP-003W/U/K

Accessories: Waterproof Packing Pole Waterproof Ring Binding Head Tapping Screw (2 pcs.)

Material: PC

■ Mounting Dimensions (Unit: mm)

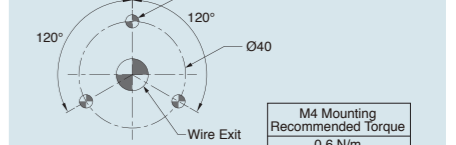

N Type Aluminum Pole Brackets



1 Depressing a locking lever on the left side of the folding bracket releases it to be lowered.

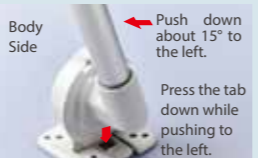

2 Press the folding bracket forward and push about 15° in the clockwise direction.

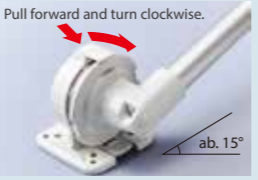

3 The folding bracket is pushed down to the right (clockwise) until it locks in place with a "Click" sound.



Folding Bracket

Model: SZQ-001W

Accessories: Pole Waterproof Ring Binding Head Tapping Screw (2 pcs.)

Material: PC

■ Mounting Dimensions (Unit: mm)

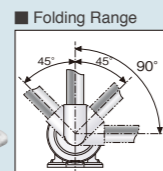
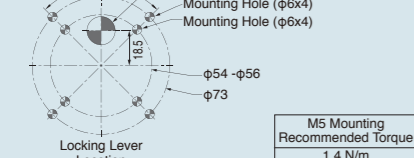

See the Movie!

T Type Aluminum Pole Brackets



L-bracket

Model: SZL-001

Material: SPHC-P

■ Mounting Dimensions (Unit: mm)

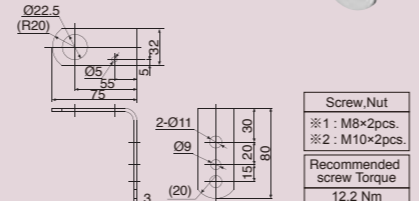

N & T Aluminum Pole Brackets



Wall-mount Bracket

Model: SZK-001U

Accessories: Hexagon Socket Set Screw (2 pcs.)

Material: ADC12

■ Mounting Dimensions (Unit: mm)

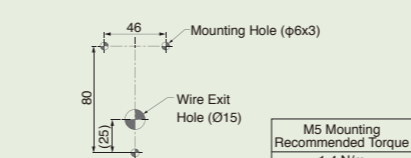

1/2" Type Pole Brackets

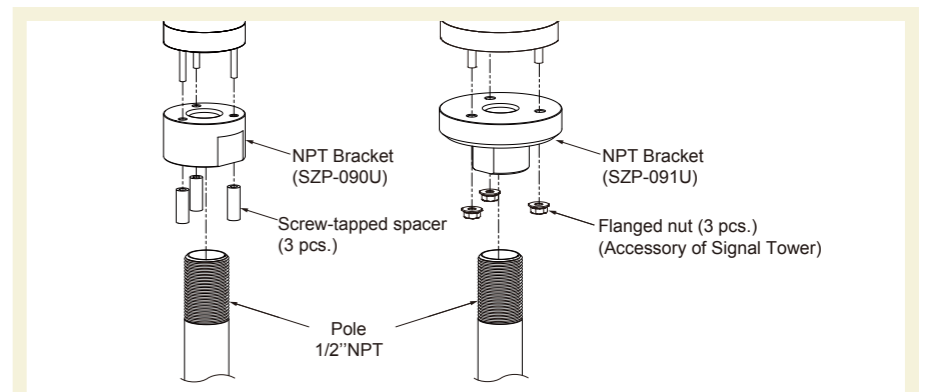

NPT Bracket

Model: SZP-090U

Accessories: Screw-tapped spacer (3 pcs.)

Material: AL

■ Mounting Dimensions (Unit: mm)

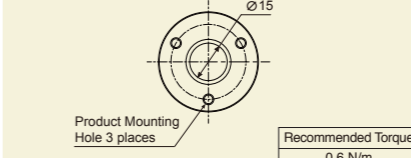

Model: SZP-091U

Material: AL

■ Mounting Dimensions (Unit: mm)

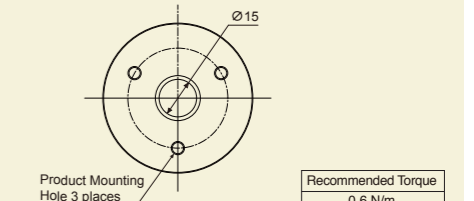

Corresponding Model · Pole List

Each Bracket Compatible Model

Model	Model Name	LR4	LR5	LR6	LR7
	SZP-001W	PJ, QJ	PJ, KT *1	PJ, QJ	KT *1
	SZP-002U	PJ, QJ	PJ, KT *1	PJ, QJ	KT *1
	SZP-003W[U][K]	PJ, QJ	PJ, KT *1	PJ, QJ	KT *1
	SZP-090U	WJ	WJ, WT, KT *2	-	-
	SZP-091U	-	-	WJ	WJ, WT, KT *2
	SZL-001	LJ	LJ, KT *1	LJ	LJ, KT *1
	SZQ-001W	PJ, QJ	PJ, KT *1	PJ, QJ	KT *1
	SZK-001U	PJ, QJ	PJ, KT *1	PJ, QJ	KT *1
	SZK-002W[U][K]	WJ	WJ, WT, KT *2	-	-
	SZK-003W[U][K]	-	-	WJ	WJ, WT, KT *2
	SZK-004W	-	-	WJ	WJ, WT, KT *2
	SZW-001W	WJ	WJ, WT, KT *2	WJ	-

*1 Required pole and pole waterproof ring are not included with KT. *2 KT Direct Mount (Using accessory)

Aluminum Poles

□ Aluminum Poles (Binding Head Tapping Screw (2pcs.) included.)

※If the pole is to be cut by the customer, it cannot be cut with a pole cutter. Please use a band saw, jigsaw, or sawing machine, etc.
 ※To convert from direct mount to pole mount, be sure to purchase the appropriate bracket and pole combination to make the change.

Model Type	Model Name	SZP-001W	SZP-002U	SZP-003W	SZQ-001W	SZK-001U	SZL-001
N Type NK Type	POLE22-0100AN[K] 100mm	○	○	○	○	○	×
	POLE22-0300AN[K] 300mm	○	○	○	○	○	×
	POLE22-0500AN 500mm	×	○	×	×	○	×
	POLE22-0800AN[K] 800mm	×	○	×	×	○	×
	POLE22-1000AN 1000mm	×	○	×	×	○	×
T Type Nuts Incl.	POLE22-0100AT 100mm	×	×	×	×	○	○
	POLE22-0300AT 300mm	×	×	×	×	○	○
	POLE22-0500AT 500mm	×	×	×	×	○	○
	POLE22-0800AT 800mm	×	×	×	×	○	○
	POLE22-1000AT 1000mm	×	×	×	×	○	○

LR Series Upcoming Products

LR Series 3rd Phase

Available in 2018

Compatible Direct Mount Bracket

The required holes to pass through the wires for the current units and the LR units are different, so a hole positioning attachment will become available in Q1, 2018. This attachment will make it easier to pass through the wires from the signal tower through the installation surface.



Note : Cable exit hole for current products and New products is different



□ Outline

Model Name	SZW-940U	SZW-950U	SZW-960U	SZW-970U
Signal Tower Size	φ40mm	φ50mm	φ60mm	φ70mm
Product Conversion	LCE-AW → LR4-WJ	LE-W/LES-AW/LU5 → LR5-WJ	LME-W → LR6-WJ	LHE/LU7 → LR7-WJ

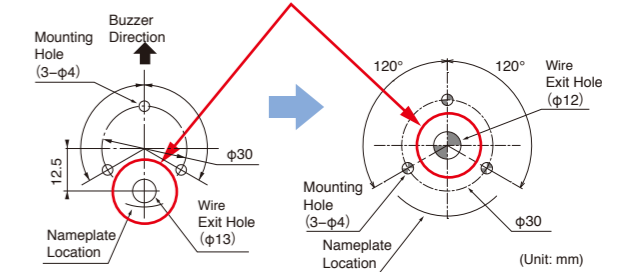

Pole-compatible Adaptor

The LCE, LE, and LES series use a 17.3mm pole and the LR series use a 21.7mm pole. The adaptor will allow users to attach pole to the place used at the diameter of 17.3mm.



□ Outline

Model Name	SZP-917U
Pole diameter compatibility	21.7mm → 17.3mm

	Model	Material	Compatible with LR Pole?
Current Product	LCE, LCS	Iron	No
	LE, LES	Iron	No
	LU5	-	-
	LME, LMS	L:Iron P:Aluminum	Yes
	LHE	-	-
	LU7	-	-
New Product	LR	Aluminum	Yes

Replacement Parts

■ O-ring (5 per pack)/Headcover

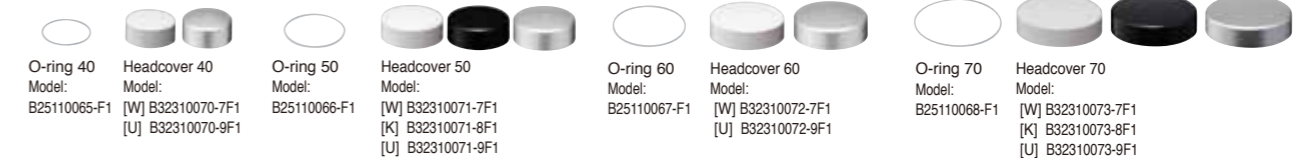

■ Base Unit

● Adaptor for Aluminum Pole
 O-ring, Binding Head Tapping Screw for pole fixing and Pole Waterproof Ring are included.

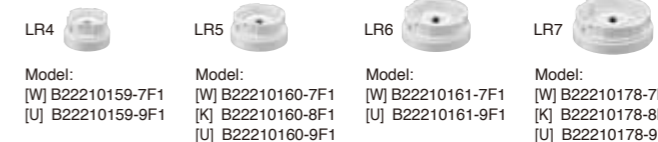

■ Terminal Block (LR5 & LR7 only)

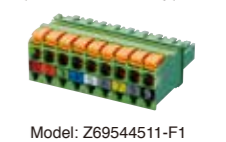

■ Filter Sheet (5 per pack)



Wiring Diagrams

Wire Type & Wire Gauge
 Wire Type: UL2464
 Wire Gauge: [01] 12V DC [02] 24V DC
 Signal Wire: AWG24
 Power Supply Wire: AWG24

Wiring Example Index	Function Name	Lead Wire Color (Cable type)	PIN No.	Terminal Type
	LED Red	Red / ①		[WT], [KT]

*Note: The lead wire color does not indicate the LED fluorescence color. Refer to pg. 16 "Terminal Block Array"

Product Specifications **[01]** 12V DC **[02]** 24V DC

External Contact Classification

Voltage Contact Relay

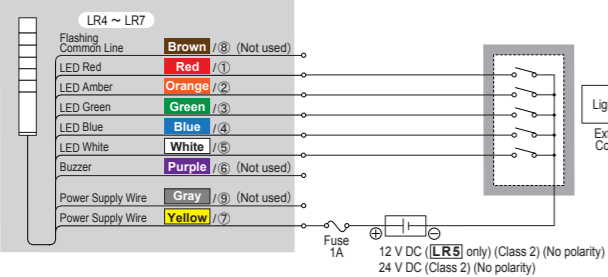

External Contact Classification

PLC (NPN Transistor)

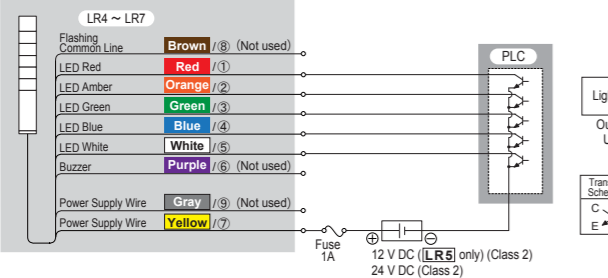

External Contact Classification

PLC (PNP Transistor)

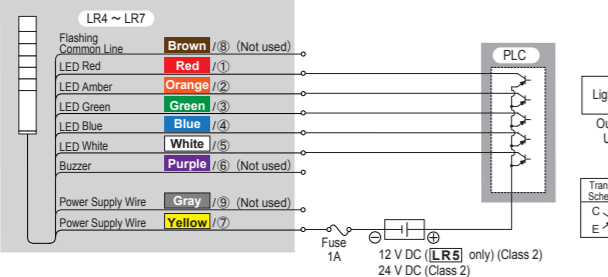

Product Specifications **[01]** 12V DC **[02]** 24V DC

External Contact Classification

Voltage Contact Relay

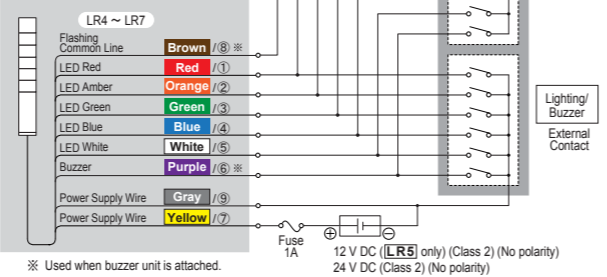

External Contact Classification

PLC (NPN Transistor)

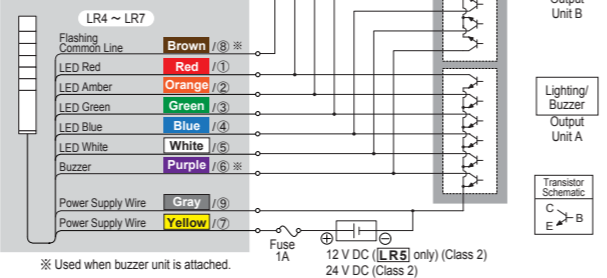

External Contact Classification

PLC (PNP Transistor)

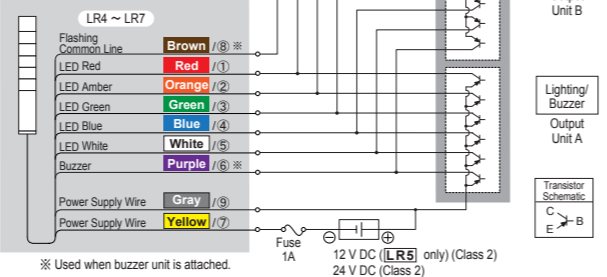

《LR Series 2-Buzzer Operation Method》
 Connecting the Buzzer wire (Purple) with the Flashing Common wire (Brown) will control the selection of two different buzzer sounds.

Product Specifications **[M2]** 100 - 240 V AC

External Contact Classification

Voltage Contact Relay

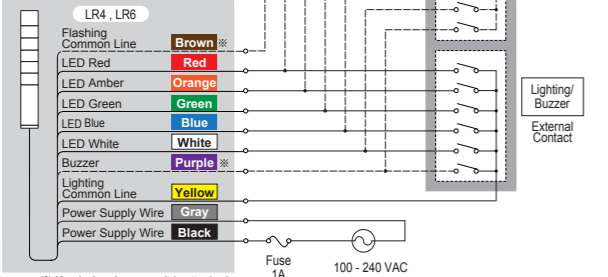

Wire Type & Wire Gauge
 Wire Type: UL2464
 Wire Gauge: [M2] 100-240V AC
 Signal Wire: AWG24
 Power Supply Wire: AWG18

External Contact Classification

PLC (NPN Transistor)

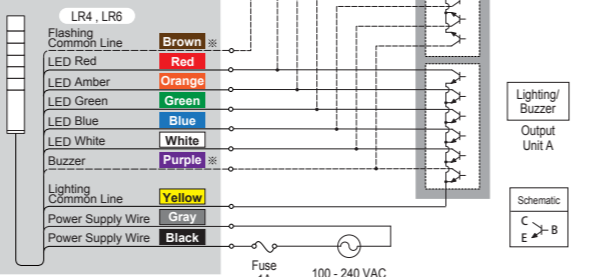

Multi-color Wiring Diagrams

Multi-color LED Unit wire colors are Red / ①; Green / ③; Blue / ④. Wire colors Orange / ② and White / ⑤ are not used.
 Refer to the Complete User's Manual for details.

LR6-E-MZ Lighting

LED Color	Wire Color
Red	Red
Green	Green
Blue	Blue
Amber	Red + Green
Purple	Red + Blue
Cyan	Green + Blue
White	Red + Green + Blue

Lighting / Flashing / Buzzer (LR6-E-MZ)

Product Specifications **[02]** 24V DC

External Contact Classification

Voltage Contact Relay

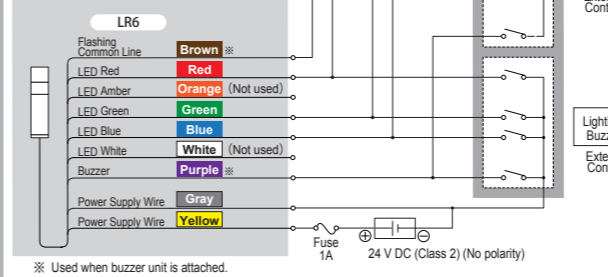

External Contact Classification

PLC (NPN Transistor)

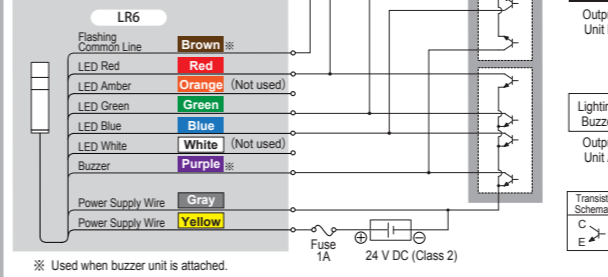

External Contact Classification

PLC (PNP Transistor)

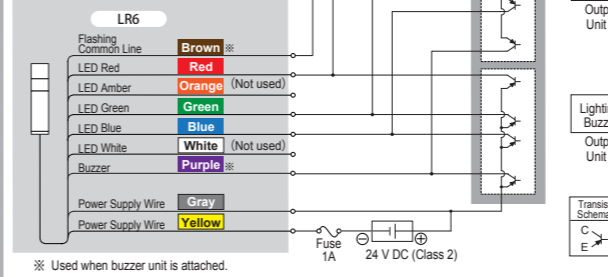

Point

When flashing the LR6-E-MZ simultaneously with the LR6-E-R(Z)/Y(Z)/G(Z)/B(Z)/C, the flashing cycle of the LR6-E-MZ may shift from the other LED units.

[WT],[KT] Terminal Type

Wiring Method

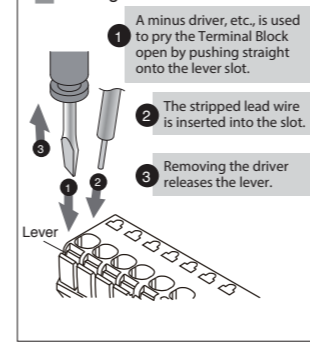

Terminal Block Array

9	Black	Power (Signal)
8	Grey	Flashing Common
7	Yellow	Power (Common)
6	Grey	Buzzer
5	White	LED White
4	Blue	LED Blue
3	Green	LED Green
2	Orange	LED Yellow
1	Red	LED Red

Recommended lead wire specification

Wire Type	Wire (Solid)	Wire (Frayed)
UL1007 / UL1430	0.14 - 1.5mm	AWG30 - 14

*Temperature rating should be above 75°C, and the conductor material should be of copper wire.

M12 (LA6-WC) Wiring Diagrams

Wiring Example Index	Function Name	PIN No.	Terminal Type
	LED Red	⑥	[WC]

Direct Mount with M12 Connector

Lighting / Buzzer (LR6-WC)

Product Specifications **[02]** [WC] 24V DC

External Contact Classification

Voltage Contact Relay

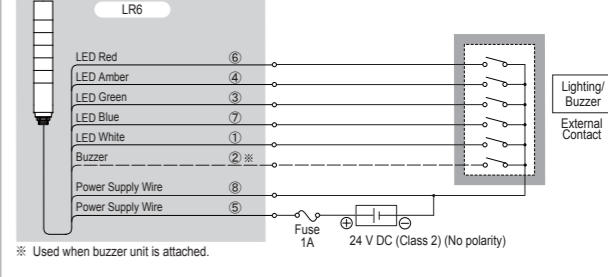

External Contact Classification

PLC (NPN Transistor)

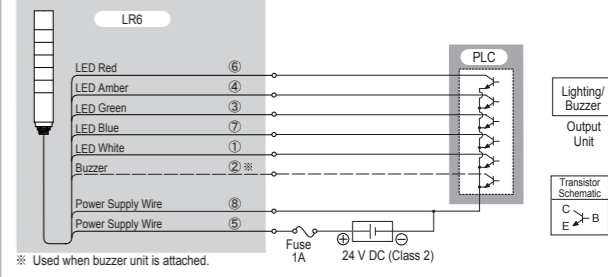

External Contact Classification

PLC (PNP Transistor)

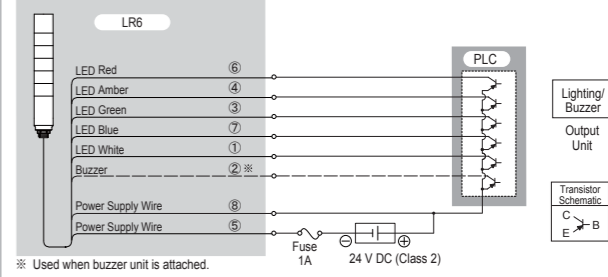

Point

The flashing function cannot be used.

M12 Connector Pin Layout

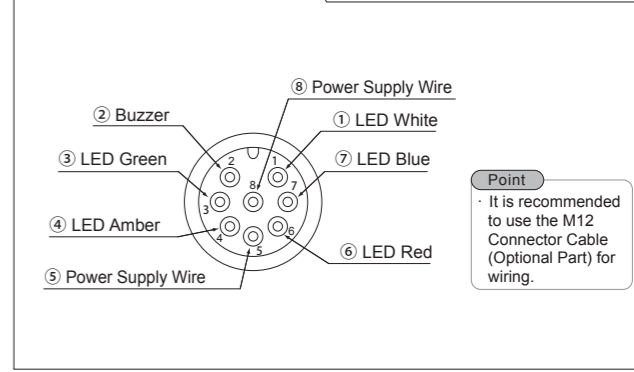

Outer Dimensional Drawing (Unit: mm)

Mount A [WJ] Direct Mount/Cable
(01: 12V DC / 02: 24V DC) (M2: 100-240V AC)

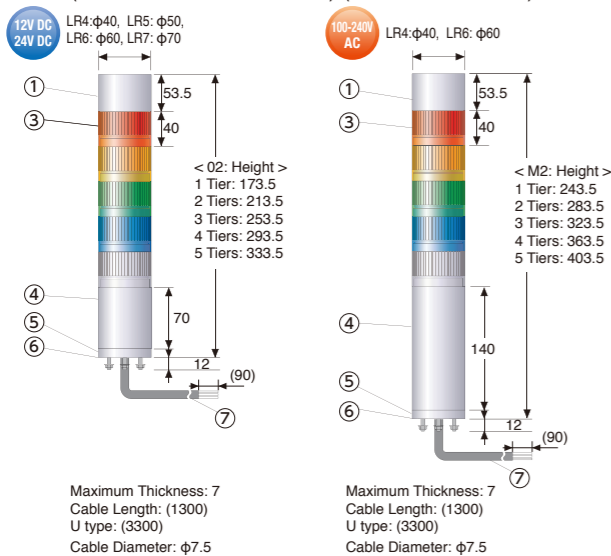

No.	Description	Material
①	Buzzer Unit	PC
②	Head Cover	PC
③	LED Unit	Globe: PC
④	Body	PC
⑤	Direct Mount Bracket	PC
⑥	Waterproof Packing	Silicon Rubber
⑦	Cable	PVC

**Mount A [WT] Direct Mount/
Screwless Terminal (Body Unit)**

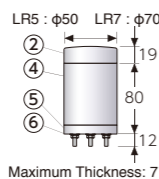

Mount B [LJ] Pole Mount with L-bracket & Cable
(01: 12V DC / 02: 24V DC) (M2: 100-240V AC)

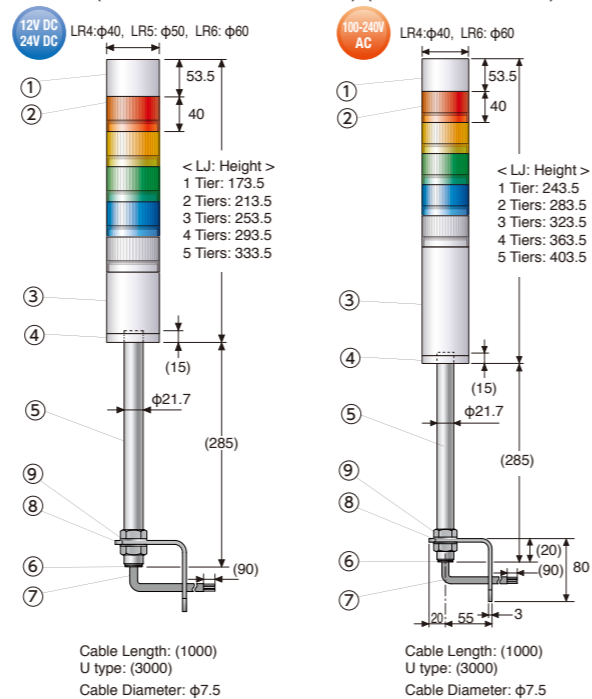

No.	Description	Material
①	Buzzer Unit	PC
②	LED Unit	Globe: PC
③	Body	PC
④	Pole Bracket	PC
⑤	Pole	AL
⑥	Rubber Bushing	EPR Rubber
⑦	Cable	PVC
⑧	L-bracket	Steel
⑨	Hexagon Nut M22	SUM

Mount A [PJ] Pole Mount with/Circular Bracket & Cable
(01: 12V DC / 02: 24V DC) (M2: 100-240V AC)

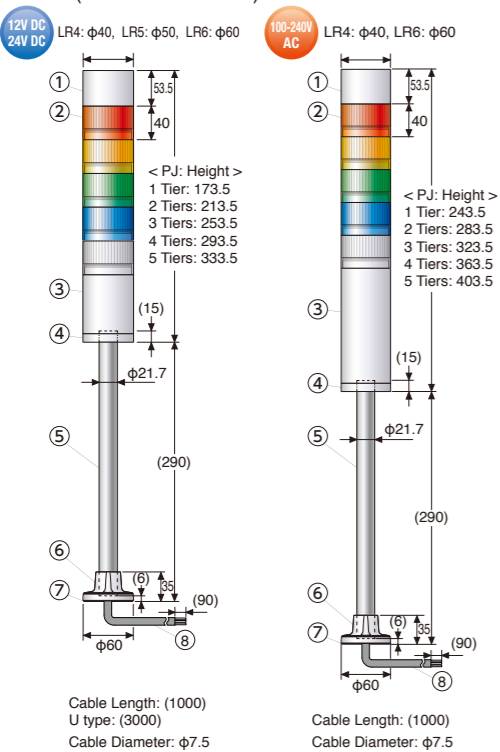

No.	Description	Material
①	Buzzer Unit	PC
②	LED Unit	Globe: PC
③	Body	PC
④	Pole Bracket	PC
⑤	Pole	AL
⑥	Circular Bracket	PC
⑦	Waterproof Packing	Silicon Rubber
⑧	Cable	PVC

Mount C [QJ] Pole Mount with/Folding Bracket & Cable
(02: 24V DC)

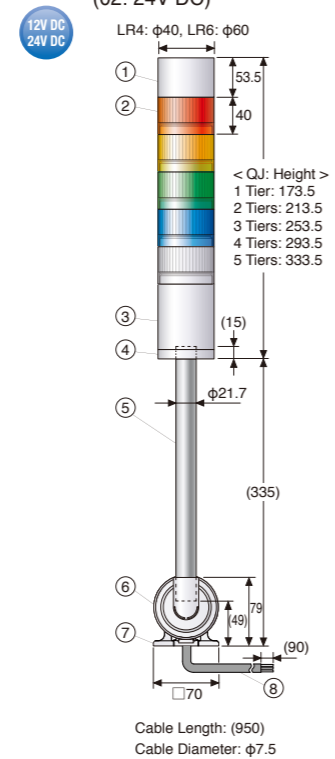

No.	Description	Material
①	Buzzer Unit	PC
②	LED Unit	Globe: PC
③	Body	PC
④	Pole Bracket	PC
⑤	Pole	AL
⑥	Folding Bracket	PC
⑦	Waterproof Packing	CR
⑧	Cable	PVC

Mount C [WC] Direct Mount with M12 Connector
(02: 24V DC)

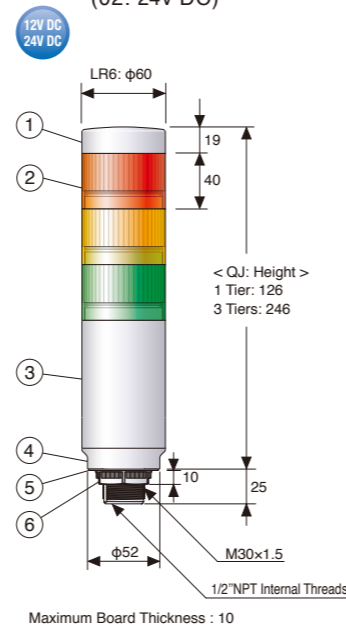

No.	Description	Material
①	Head Cover	PC
②	LED Unit	Globe: PC
③	Body	PC
④	Direct Mount Bracket	PC
⑤	Waterproof Packing (1=1)	Silicone Rubber
⑥	M30 Nut	PC

Mounting Dimensions (Unit: mm)

Mount A Mounting Diagram
[WJ] / [PJ] / [WT] / [KT]

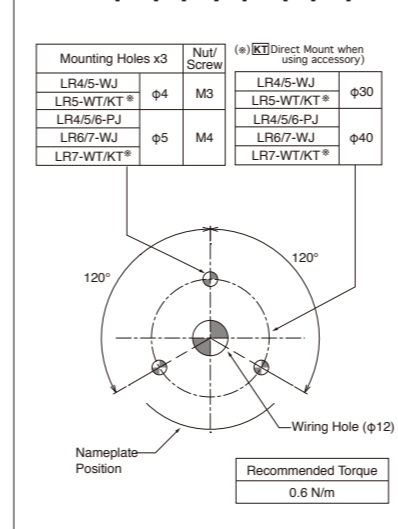

Mount B Mounting Diagram
[LJ]

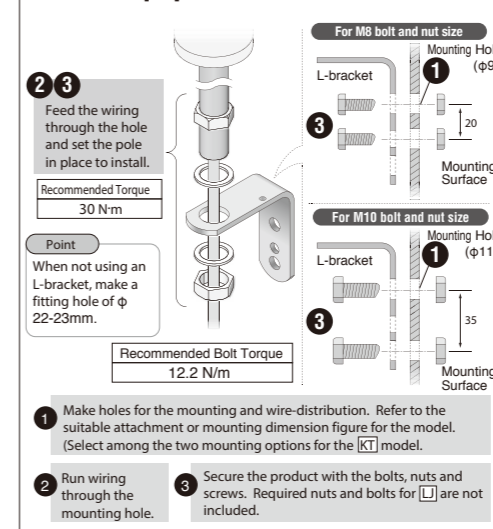

Mount C Mounting Diagram
[QJ]

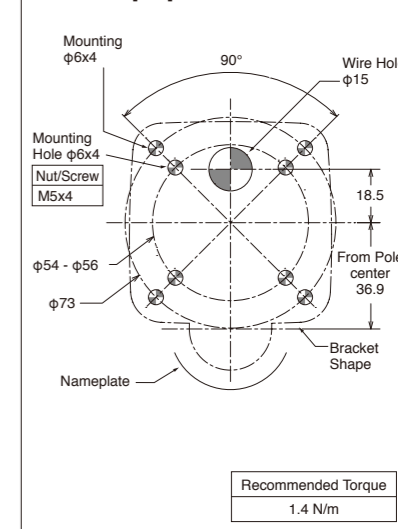

Specifications

Operating Ambient Temperature	-20 - +50 °C
Operating Ambient Humidity	Less than 90% RH (No Condensation)
Storage Ambient Temperature	-30 - +60 °C
Storage Ambient Humidity	Less than 90% RH (No Condensation)
Mounting Location	Indoor Only
Mounting Direction	Upright
Protection Rating*1	IP65 (IEC 60529) / NEMA TYPE 4X, 13
Environmental Conditions	Upright
Insulation Resistance	More than 1MΩ at DC500V between live part and non-current carrying metallic part
Withstand Voltage	500V AC applied for 1 minute between live part and non-current carrying metallic part without breaking insulation (M2: 1500V AC for 1 min.)
Flash Rate	60 ±2 Flashes Per Minute
Sound Pressure Level	LR4 Typ. 85dB LR5 Typ. 85dB LR6 Typ. 88dB LR7 Typ. 90dB LR5 DC12V Typ. 80dB
Sound Reduction*2	Approx. -10dB
Environmental Conditions	Buzzer Sound No.4 was measured from the total circumference of the Buzzer Unit at 1m
Buzzer Sound	4 patterns*2 No.1 Rapid Intermittent beep No.2 Continuous beep sound No.3 Rapid Hi-low No.4 Sweep sound
Transistor Output	NPN / PNP (100 - 240V AC is NPN only)
Conformity Standards	<ul style="list-style-type: none"> UL 508, CSA-C22.2 No.14 FCC Part 15 Subpart B Class A RoHS Directive (EN 50581) EMC Directive (EN 61000-6-4, EN 61000-6-2) KC (KN 61000-6-4, KN 61000-6-2)*3 Low-voltage Directive (IEC/EN 60947-5-1, EN62471)*4

*1: LJ Type is IP54 *2: Dependent on DIP Switch Settings *3: Except KT and M2 LJ Type *4: M2 Type Only (Except LJ Type)

External Contact Capacity

Rated Load Voltage	Is:Current Capacity Vs:Withstand Voltage I _L :Leakage Current Ta:Ambient Temperature		
	01 12V DC	02 24V DC	M2 100 - 240V AC
LED Unit (1 Tier)	Signal Wire Current (Max.) / Voltage	100mA / Power Supply Voltage	45mA / Power Supply Voltage
	Recommended Contact Capacity	I _s ≥ 100mA Vs ≥ 20V DC ⁻¹	I _s ≥ 100mA Vs ≥ 35V DC
Buzzer	Signal Wire Current (Max.) / Voltage	250mA / Power Supply Voltage	250mA / Power Supply Voltage
	Recommended Contact Capacity	I _s ≥ 300mA Vs ≥ 20V DC ⁻¹	I _s ≥ 300mA Vs ≥ 35V DC
Power Supply	Current Consumption (Max.)	500mA	250mA
	Recommended Contact Capacity	I _s ≥ 700mA Vs ≥ 20VDC	I _s ≥ 500mA Vs ≥ 35V DC
Inrush Current	Signal Wire	LED None ⁻¹ / Buzzer None	LED None / Buzzer None
	Power Supply Wire	0.7A / Less than 15ms	None
Leakage Current	I _L ≤ 0.1 mA		

*1: When the (Gray for [WJ] [LJ] [PJ] [QJ], Black / ⑨ for [WT] [KT], ⑧ for [WC]) power supply wire is not connected, inrush current of 0.7A will flow through the signal wire.
Recommended Contact Capacity: ≥ 700mA Vs ≥ 20VDC

LED Unit Specifications

Color	Red	Amber	Green	Blue	White	Multi-color
Rated Voltage	24V DC					
Current Consumption	Typ.	0.04A				
	Max.	0.045A				
Power Consumption	Typ.	1W				
	Max.	1.3W				
Conformity Standards	<ul style="list-style-type: none"> UL 508, CSA-C22.2 No.14 RoHS Directive (EN 50581) EMC Directive (EN 61000-6-4, EN 61000-6-2) 					

Buzzer Unit Specifications

Rated Voltage	24V DC	
Current Consumption	Typ.	0.04A
	Max.	0.3A
Power Consumption	Typ.	1W
	Max.	1.3W
Conformity Standards	<ul style="list-style-type: none"> UL 508, CSA-C22.2 No.14 RoHS Directive (EN 50581) EMC Directive (EN 61000-6-4, EN 61000-6-2) FCC Part 15 Subpart B Class A 	

LR Series Compatibility Chart (φ40 - φ50)

Current Models					Succeeding Models			
Series	Voltage	Installation Type	Buzzer	Model	Model	Comment	Installation Pitch	Fixed Wiring Hole
LCE-(A) φ40	24V AC/DC	Direct Mount	○	LCE-102(A)FBW	LR4-102WJWB		○	×
				LCE-202(A)FBW	LR4-202WJWB		○	×
				LCE-302(A)FBW	LR4-302WJWB		○	×
				LCE-402(A)FBW	LR4-402WJWB		○	×
				LCE-502(A)FBW	LR4-502WJWB		○	×
				LCE-102(A)W	LR4-102WJNW		○	×
				LCE-202(A)W	LR4-202WJNW		○	×
				LCE-302(A)W	LR4-302WJNW		○	×
				LCE-402(A)W	LR4-402WJNW		○	×
		LCE-502(A)W	LR4-502WJNW		○	×		
		Pole Mount (L-bracket)	○	LCE-102(A)FB	LR4-102LJBW		○	○
				LCE-202(A)FB	LR4-202LJBW		○	○
				LCE-302(A)FB	LR4-302LJBW		○	○
				LCE-402(A)FB	LR4-402LJBW		○	○
				LCE-502(A)FB	LR4-502LJBW		○	○
	LCE-102(A)			LR4-102LJNW		○	○	
	Pole Mount (Wall-mount Bracket)	○	LCE-102(A)FBK	LR4-102PJBW	Purchase SZK-001 U option bracket additionally.	×	×	
			LCE-202(A)FBK	LR4-202PJBW		×	×	
			LCE-302(A)FBK	LR4-302PJBW		×	×	
			LCE-402(A)FBK	LR4-402PJBW		×	×	
			LCE-502(A)FBK	LR4-502PJBW		×	×	
LCE-102(A)			LR4-102LJNB	○		○		
90 - 250V AC	Direct Mount	○	LCE-1M2(A)FBW	LR4-1M2WJWB		○	×	
			LCE-2M2(A)FBW	LR4-2M2WJWB		○	×	
			LCE-3M2(A)FBW	LR4-3M2WJWB		○	×	
			LCE-4M2(A)FBW	LR4-4M2WJWB		○	×	
			LCE-5M2(A)FBW	LR4-5M2WJWB		○	×	
			LCE-1M2(A)W	LR4-1M2WJNW		○	×	
			LCE-2M2(A)W	LR4-2M2WJNW		○	×	
			LCE-3M2(A)W	LR4-3M2WJNW		○	×	
			LCE-4M2(A)W	LR4-4M2WJNW		○	×	
	LCE-5M2(A)W	LR4-5M2WJNW		○	×			
	Pole Mount (L-bracket)	○	LCE-1M2(A)FB	LR4-1M2LJBW		○	○	
			LCE-2M2(A)FB	LR4-2M2LJBW		○	○	
			LCE-3M2(A)FB	LR4-3M2LJBW		○	○	
			LCE-4M2(A)FB	LR4-4M2LJBW		○	○	
			LCE-5M2(A)FB	LR4-5M2LJBW		○	○	
LCE-1M2(A)			LR4-1M2LJNB		○	○		
LCS-(A) φ40	24V AC/DC	Pole Mount (L-bracket)	×	LCS-102(A)	LR4-102LJNW		○	○
				LCS-202(A)	LR4-202LJNW		○	○
				LCS-302(A)	LR4-302LJNW		○	○
				LCS-402(A)	LR4-402LJNW		○	○
				LCS-502(A)	LR4-502LJNW		○	○
				LCS-102(A)K	LR4-102PJNW		×	×
				LCS-202(A)K	LR4-202PJNW		×	×
				LCS-302(A)K	LR4-302PJNW		×	×
				LCS-402(A)K	LR4-402PJNW		×	×
	LCS-502(A)K	LR4-502PJNW		×	×			
	Wall-mount Bracket	×	LCS-102(A)	LR4-102LJNB		○	○	
			LCS-202(A)	LR4-202LJNB		○	○	
			LCS-302(A)	LR4-302LJNB		○	○	
			LCS-402(A)	LR4-402LJNB		○	○	
			LCS-502(A)	LR4-502LJNB		○	○	
LCS-102(A)			LR4-102LJNB		○	○		
LE φ50	12V AC/DC	Direct Mount	○	LE-101FBW	LR5-101WJWB		○	×
				LE-201FBW	LR5-201WJWB		○	×
				LE-301FBW	LR5-301WJWB		○	×
				LE-401FBW	LR5-401WJWB		○	×
				LE-501FBW	LR5-501WJWB		○	×
				LE-101W	LR5-101WJNW		○	×
				LE-201W	LR5-201WJNW		○	×
				LE-301W	LR5-301WJNW		○	×
				LE-401W	LR5-401WJNW		○	×
		LE-501W	LR5-501WJNW		○	×		
		Pole Mount (L-bracket)	○	LE-101FBP	LR5-101LJBW		○	○
				LE-201FBP	LR5-201LJBW		○	○
				LE-301FBP	LR5-301LJBW		○	○
				LE-401FBP	LR5-401LJBW		○	○
				LE-501FBP	LR5-501LJBW		○	○
LE-101P	LR5-101LJNW				○	○		
Pole Mount (L-bracket)	×	LE-201P	LR5-201LJNW		○	○		
		LE-301P	LR5-301LJNW		○	○		
		LE-401P	LR5-401LJNW		○	○		
		LE-501P	LR5-501LJNW		○	○		

LR Series Compatibility Chart (φ50 - φ60)

Current Models					Succeeding Models			
Series	Voltage	Installation Type	Buzzer	Model	Model	Comment	Installation Pitch	Fixed Wiring Hole
LE φ50	24V AC/DC	Direct Mount	○	LE-102FBW	LR5-102WJWB		○	×
				LE-202FBW	LR5-202WJWB		○	×
				LE-302FBW	LR5-302WJWB		○	×
				LE-402FBW	LR5-402WJWB		○	×
				LE-502FBW	LR5-502WJWB		○	×
				LE-102W	LR5-102WJNW		○	×
				LE-202W	LR5-202WJNW		○	×
				LE-302W	LR5-302WJNW		○	×
				LE-402W	LR5-402WJNW		○	×
		LE-502W	LR5-502WJNW		○	×		
		Pole Mount (L-bracket)	○	LE-102FBP	LR5-102LJBW		○	○
				LE-202FBP	LR5-202LJBW		○	○
				LE-302FBP	LR5-302LJBW		○	○
				LE-402FBP	LR5-402LJBW		○	○
				LE-502FBP	LR5-502LJBW		○	○
LE-102P	LR5-102LJNW				○	○		
Pole Mount (L-bracket)	×	LE-202P	LR5-202LJNW		○	○		
		LE-302P	LR5-302LJNW		○	○		
		LE-402P	LR5-402LJNW		○	○		
		LE-502P	LR5-502LJNW		○	○		
		LE-110FBW / LE-120FBW	LR4-1M2WJWB		○	×		
		LE-210FBW / LE-220FBW	LR4-2M2WJWB		○	×		
LE-310FBW / LE-320FBW	LR4-3M2WJWB		○	×				
LE-410FBW / LE-420FBW	LR4-4M2WJWB		○	×				
LE-510FBW / LE-520FBW	LR4-5M2WJWB		○	×				
LE φ50	100V AC / 220V AC	Direct Mount	○	LE-110W / LE-120W	LR4-1M2WJNW		○	×
				LE-210W / LE-220W	LR4-2M2WJNW		○	×
				LE-310W / LE-320W	LR4-3M2WJNW		○	×
				LE-410W / LE-420W	LR4-4M2WJNW		○	×
				LE-510W / LE-520W	LR4-5M2WJNW		○	×
				LE-110FBP / LE-120FBP	LR4-1M2LJBW		○	○
				LE-210FBP / LE-220FBP	LR4-2M2LJBW		○	○
				LE-310FBP / LE-320FBP	LR4-3M2LJBW		○	○
				LE-410FBP / LE-420FBP	LR4-4M2LJBW		○	○
		LE-510FBP / LE-520FBP	LR4-5M2LJBW		○	○		
		Pole Mount (L-bracket)	○	LE-110P / LE-120P	LR4-1M2LJNW		○	○
				LE-210P / LE-220P	LR4-2M2LJNW		○	○
				LE-310P / LE-320P	LR4-3M2LJNW		○	○
				LE-410P / LE-420P	LR4-4M2LJNW		○	○
				LE-510P / LE-520P	LR4-5M2LJNW		○	○
LES-102AW	LR5-102WJNW				×	×		
LES-202AW	LR5-202WJNW		×	×				
LES-302AW	LR5-302WJNW		×	×				
LES-402AW	LR5-402WJNW		×	×				
LES-502AW	LR5-502WJNW		×	×				
LES-A φ50	24V AC/DC	Direct Mount	×	LES-102A	LR5-102LJNW		○	○
				LES-202A	LR5-202LJNW		○	○
				LES-302A	LR5-302LJNW		○	○
				LES-402A	LR5-402LJNW		○	○
				LES-502A	LR5-502LJNW		○	○
				LU5-02FB	LR5-02WJNW		○	×
LU5-02	LR5-02WJNB		○	×				
LME φ60	24V AC/DC	Direct Mount	○	LME-102FBW	LR6-102WJWB		○	×
				LME-202FBW	LR6-202WJWB		○	×
				LME-302FBW	LR6-302WJWB		○	×
				LME-402FBW	LR6-402WJWB		○	×
				LME-502FBW	LR6-502WJWB		○	×
				LME-102W	LR6-102WJNW		○	×
				LME-202W	LR6-202WJNW		○	×
				LME-302W	LR6-302WJNW		○	×
				LME-402W	LR6-402WJNW		○	×
		LME-502W	LR6-502WJNW		○	×		
		Pole Mount (Circular-mount Bracket)	○	LME-102FB	LR6-102PJBW		○	×
				LME-202FB	LR6-202PJBW		○	×
				LME-302FB	LR6-302PJBW		○	×
				LME-402FB	LR6-402PJBW		○	×
				LME-502FB	LR6-502PJBW		○	×
LME-102	LR6-102PJNW				○	×		
Pole Mount (L-bracket)	×	LME-202	LR6-202PJNW		○	×		
		LME-302	LR6-302PJNW		○	×		
		LME-402	LR6-402PJNW		○	×		
		LME-502	LR6-502PJNW		○	×		

LR Series Compatibility Chart (φ60 - φ70)

Current Models					Succeeding Models			
Series	Voltage	Installation Type	Buzzer	Model	Model	Comment	Installation Pitch	Fixed Wiring Hole
LME φ60	24V AC/DC	Pole Mount (L-bracket)	○	LME-102FBL	LR6-102LJBW		○	○
				LME-202FBL	LR6-202LJBW		○	○
				LME-302FBL	LR6-302LJBW		○	○
				LME-402FBL	LR6-402LJBW		○	○
				LME-502FBL	LR6-502LJBW		○	○
				LME-102L	LR6-102LJNW		○	○
		LME-202L	LR6-202LJNW		○	○		
		LME-302L	LR6-302LJNW		○	○		
		LME-402L	LR6-402LJNW		○	○		
		LME-502L	LR6-502LJNW		○	○		
		Pole Mount (Wall-mount Bracket)	×	LME-102FBK	LR6-102PJBW		×	×
				LME-202FBK	LR6-202PJBW		×	×
	LME-302FBK			LR6-302PJBW		×	×	
	LME-402FBK			LR6-402PJBW		×	×	
	LME-502FBK			LR6-502PJBW		×	×	
	100V AC / 120V AC	Direct Mount	○	LME-110FBW / LME-112FBW	LR6-1M2WJBW		○	×
				LME-210FBW / LME-212FBW	LR6-2M2WJBW		○	×
				LME-310FBW / LME-312FBW	LR6-3M2WJBW		○	×
				LME-410FBW / LME-412FBW	LR6-4M2WJBW		○	×
				LME-510FBW / LME-512FBW	LR6-5M2WJBW		○	×
				LME-110W / LME-112W	LR6-1M2WJNW		○	×
		LME-210W / LME-212W	LR6-2M2WJNW		○	×		
		LME-310W / LME-312W	LR6-3M2WJNW		○	×		
LME-410W / LME-412W		LR6-4M2WJNW		○	×			
LME-510W / LME-512W		LR6-5M2WJNW		○	×			
Pole Mount (Circular-mount Bracket)		○	LME-110FB / LME-112FB	LR6-1M2PJBW		○	×	
			LME-210FB / LME-212FB	LR6-2M2PJBW		○	×	
	LME-310FB / LME-312FB		LR6-3M2PJBW		○	×		
	LME-410FB / LME-412FB		LR6-4M2PJBW		○	×		
	LME-510FB / LME-512FB		LR6-5M2PJBW		○	×		
	LME-110 / LME-112		LR6-1M2PJNW		○	×		
LME-210 / LME-212	LR6-2M2PJNW		○	×				
LME-310 / LME-312	LR6-3M2PJNW		○	×				
LME-410 / LME-412	LR6-4M2PJNW		○	×				
LME-510 / LME-512	LR6-5M2PJNW		○	×				
220V AC / 230V AC	Pole Mount (L-bracket)	×	LME-110FBL / LME-112FBL	LR6-1M2LJBW		○	○	
			LME-210FBL / LME-212FBL	LR6-2M2LJBW		○	○	
			LME-310FBL / LME-312FBL	LR6-3M2LJBW		○	○	
			LME-410FBL / LME-412FBL	LR6-4M2LJBW		○	○	
			LME-510FBL / LME-512FBL	LR6-5M2LJBW		○	○	
			LME-110L / LME-112L	LR6-1M2LJNW		○	○	
	LME-210L / LME-212L	LR6-2M2LJNW		○	○			
	LME-310L / LME-312L	LR6-3M2LJNW		○	○			
	LME-410L / LME-412L	LR6-4M2LJNW		○	○			
	LME-510L / LME-512L	LR6-5M2LJNW		○	○			
	Direct Mount	○	LME-120FBW / LME-123FBW	LR6-1M2WJBW		○	×	
			LME-220FBW / LME-223FBW	LR6-2M2WJBW		○	×	
LME-320FBW / LME-323FBW			LR6-3M2WJBW		○	×		
LME-420FBW / LME-423FBW			LR6-4M2WJBW		○	×		
LME-520FBW / LME-523FBW			LR6-5M2WJBW		○	×		
LME-120W / LME-123W			LR6-1M2WJNW		○	×		
LME-220W / LME-223W	LR6-2M2WJNW		○	×				
LME-320W / LME-323W	LR6-3M2WJNW		○	×				
LME-420W / LME-423W	LR6-4M2WJNW		○	×				
LME-520W / LME-523W	LR6-5M2WJNW		○	×				
Pole Mount (Circular-mount Bracket)	○	LME-120FB / LME-123FB	LR6-1M2PJBW		○	×		
		LME-220FB / LME-223FB	LR6-2M2PJBW		○	×		
		LME-320FB / LME-323FB	LR6-3M2PJBW		○	×		
		LME-420FB / LME-423FB	LR6-4M2PJBW		○	×		
		LME-520FB / LME-523FB	LR6-5M2PJBW		○	×		
		LME-120 / LME-123	LR6-1M2PJNW		○	×		
LME-220 / LME-223	LR6-2M2PJNW		○	×				
LME-320 / LME-323	LR6-3M2PJNW		○	×				
LME-420 / LME-423	LR6-4M2PJNW		○	×				
LME-520 / LME-523	LR6-5M2PJNW		○	×				
Pole Mount (L-bracket)	×	LME-120FBL / LME-123FBL	LR6-1M2LJBW		○	○		
		LME-220FBL / LME-223FBL	LR6-2M2LJBW		○	○		
		LME-320FBL / LME-323FBL	LR6-3M2LJBW		○	○		
		LME-420FBL / LME-423FBL	LR6-4M2LJBW		○	○		
		LME-520FBL / LME-523FBL	LR6-5M2LJBW		○	○		
		LME-120L / LME-123L	LR6-1M2LJNW		○	○		
LME-220L / LME-223L	LR6-2M2LJNW		○	○				
LME-320L / LME-323L	LR6-3M2LJNW		○	○				
LME-420L / LME-423L	LR6-4M2LJNW		○	○				
LME-520L / LME-523L	LR6-5M2LJNW		○	○				

LR Series Compatibility Chart (φ60 - φ70)

Current Models					Succeeding Models						
Series	Voltage	Installation Type	Buzzer	Model	Model	Comment	Installation Pitch	Fixed Wiring Hole			
LMS φ60	24V AC/DC	Pole Mount (Circular-mount Bracket)	×	LMS-102	LR6-102PJNW		○	×			
				LMS-202	LR6-202PJNW		○	×			
				LMS-302	LR6-302PJNW		○	×			
				LMS-402	LR6-402PJNW		○	×			
		Pole Mount (L-bracket)	×	LMS-502	LR6-502PJNW		○	×			
				LMS-102L	LR6-102LJNW		○	○			
				LMS-202L	LR6-202LJNW		○	○			
				LMS-302L	LR6-302LJNW		○	○			
		Pole Mount (Wall-mount Bracket)	×	LMS-402L	LR6-402LJNW		○	○			
				LMS-502L	LR6-502LJNW		○	○			
				LMS-102K	LR6-102PJNW		×	×			
				LMS-202K	LR6-202PJNW		×	×			
LHE-A φ70	24V AC/DC	Direct Mount	○	LHE-102AFB	LR7-102WJBW		○	×			
				LHE-202AFB	LR7-202WJBW		○	×			
				LHE-302AFB	LR7-302WJBW		○	×			
				LHE-402AFB	LR7-402WJBW		○	×			
				LHE-502AFB	LR7-502WJBW		○	×			
				LHE-102A	LR7-102WJNW		○	×			
	100V AC / 120V AC	Direct Mount	○	LHE-202A	LR7-202WJNW		○	×			
				LHE-302A	LR7-302WJNW		○	×			
				LHE-402A	LR7-402WJNW		○	×			
				LHE-502A	LR7-502WJNW		○	×			
				220V AC	Direct Mount	○	LHE-110AFB / LHE-112AFB	LR6-1M2WJBW		○	×
							LHE-210AFB / LHE-212AFB	LR6-2M2WJBW		○	×
LHE-310AFB / LHE-312AFB	LR6-3M2WJBW		○				×				
LHE-410AFB / LHE-412AFB	LR6-4M2WJBW		○				×				
LHE-510AFB / LHE-512AFB	LR6-5M2WJBW		○				×				
LHE-110A / LHE-112A	LR6-1M2WJNW		○				×				
24V DC	Direct Mount	○	LHE-210A / LHE-212A	LR6-2M2WJNW		○	×				
			LHE-310A / LHE-312A	LR6-3M2WJNW		○	×				
			LHE-410A / LHE-412A	LR6-4M2WJNW		○	×				
			LHE-510A / LHE-512A	LR6-5M2WJNW		○	×				
			LHE-120AFB	LR6-1M2WJBW		○	×				
			LHE-220AFB	LR6-2M2WJBW		○	×				
90 - 250V AC	Direct Mount	○	LHE-320AFB	LR6-3M2WJBW		○	×				
			LHE-420AFB	LR6-4M2WJBW		○	×				
			LHE-520AFB	LR6-5M2WJBW		○	×				
			LHE-120A	LR6-1M2WJNW		○	×				
			LHE-220A	LR6-2M2WJNW		○	×				
			LHE-320A	LR6-3M2WJNW		○	×				
LU7 φ70	24V DC	Direct Mount	○	LU7-02FB	LR7-02WTNW		○	×			
				LU7-02	LR7-02WTNW		○	×			
				LU7-M2FB	LR6-M2WJNW	Purchase LR6-BW additionally for φ60 size.	○	×			
				LU7-M2	LR6-M2WJNW	Available for φ60 only.	○	×			

